



BOURGEOISIE DE SION



VILLE DE SION

Liaison plaine - montagne

Sion - Mayens de l'Hôpital

19.02.2019

Document de travail à l'usage du Conseil général

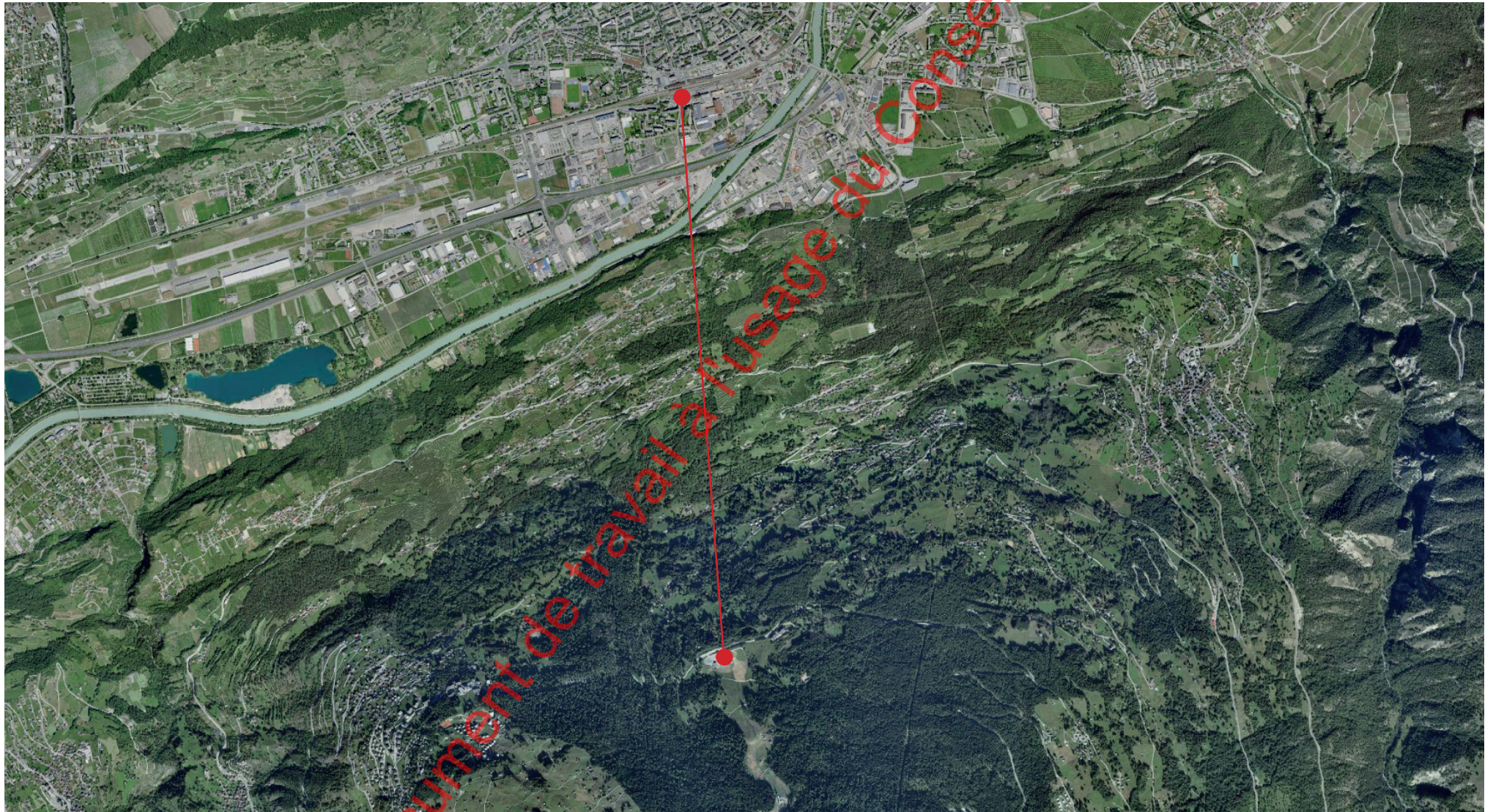

Situation générale

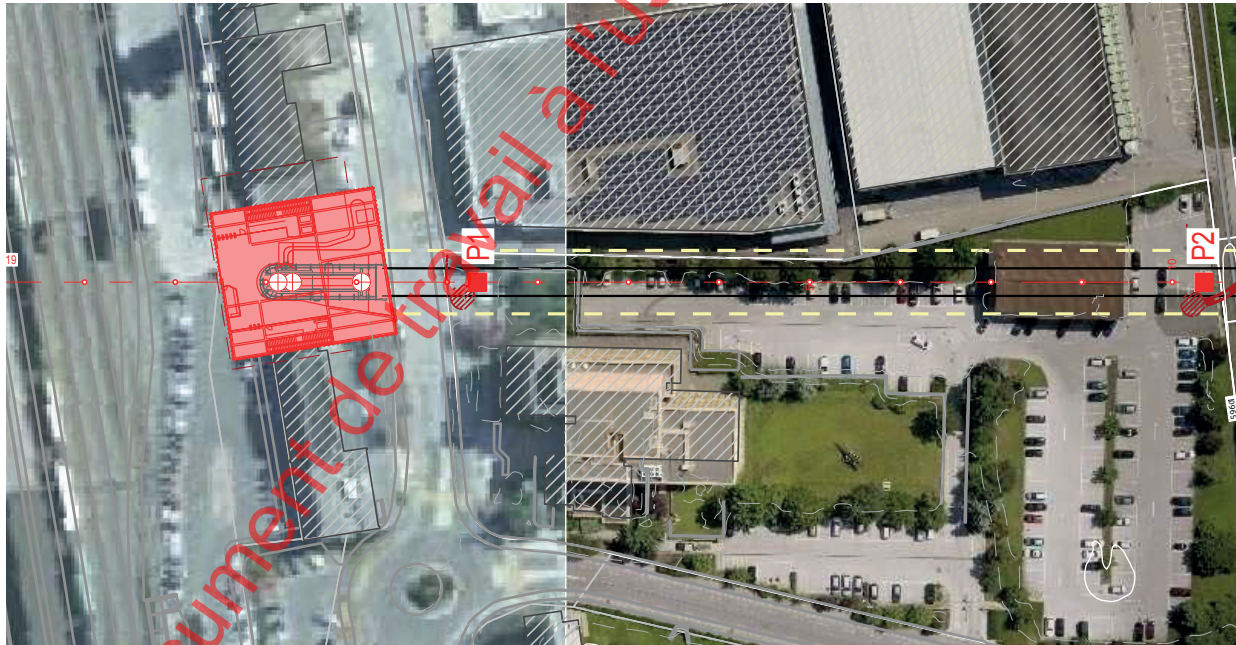
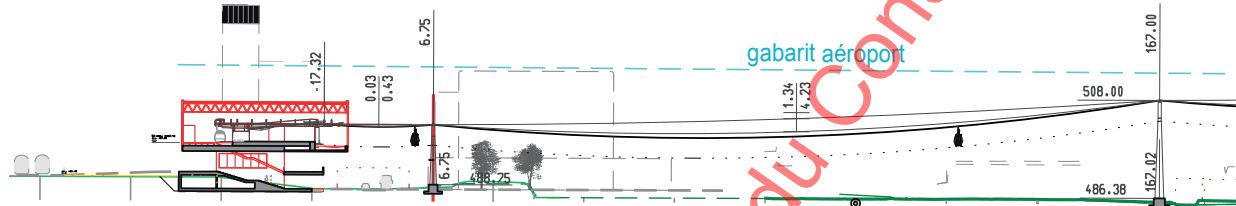

Tracé de la liaison

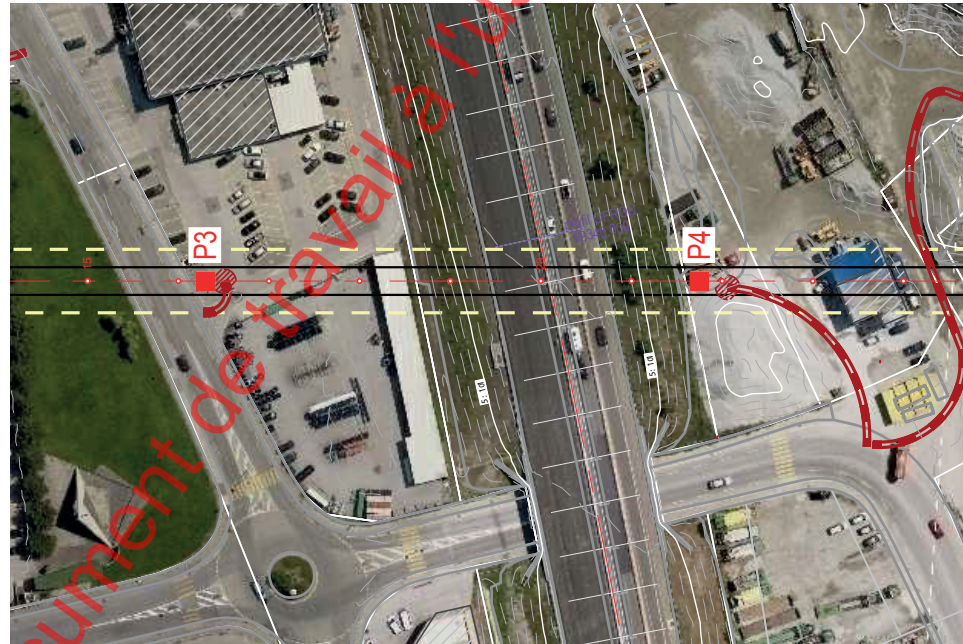
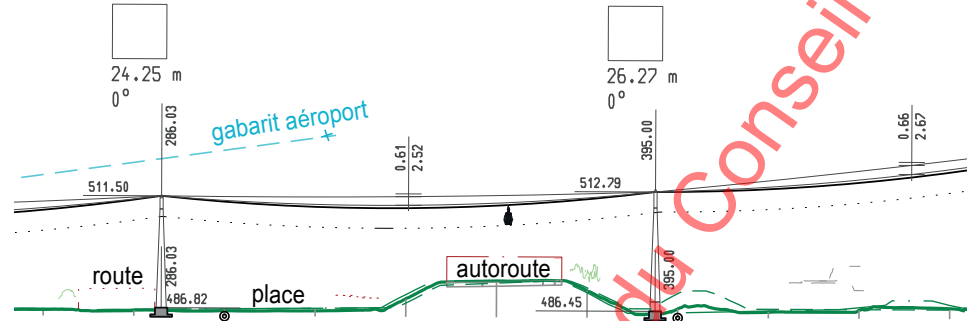

Tracé de la liaison

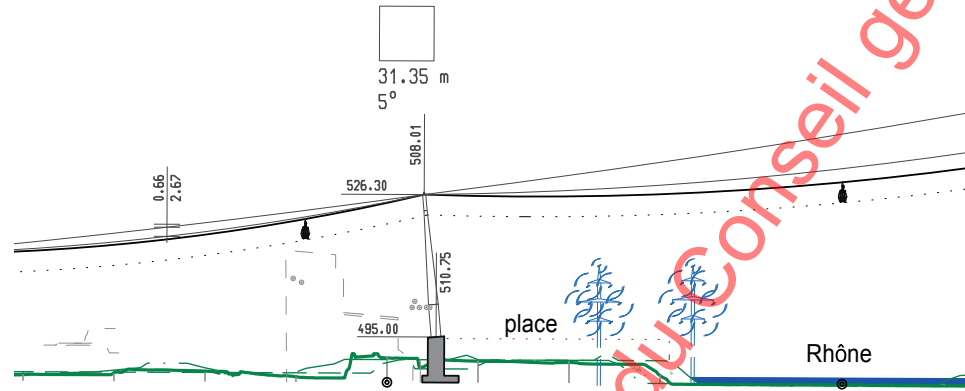

Tracé de la liaison

Document de travail à l'usage du Conseil général

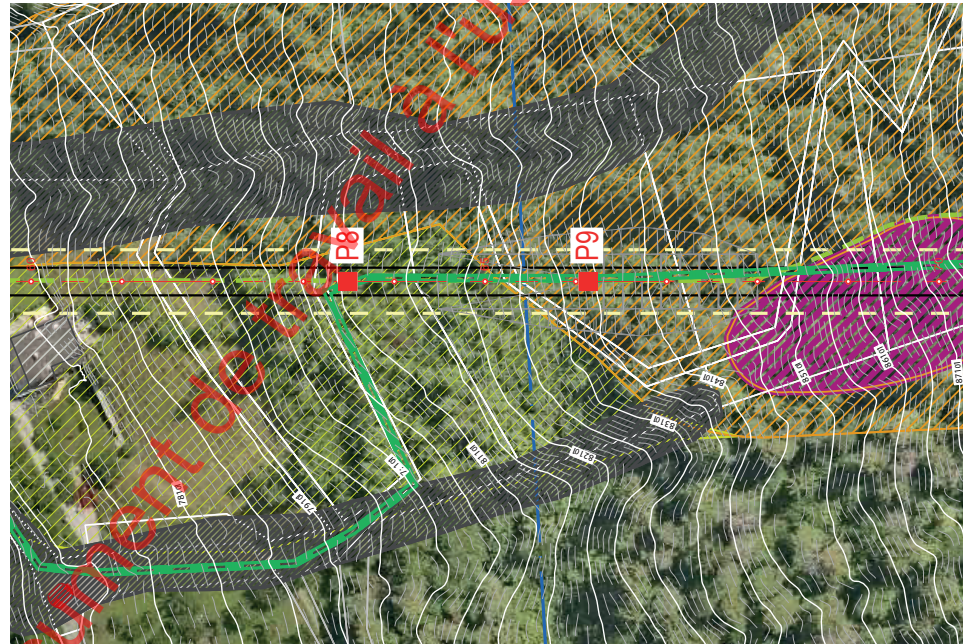
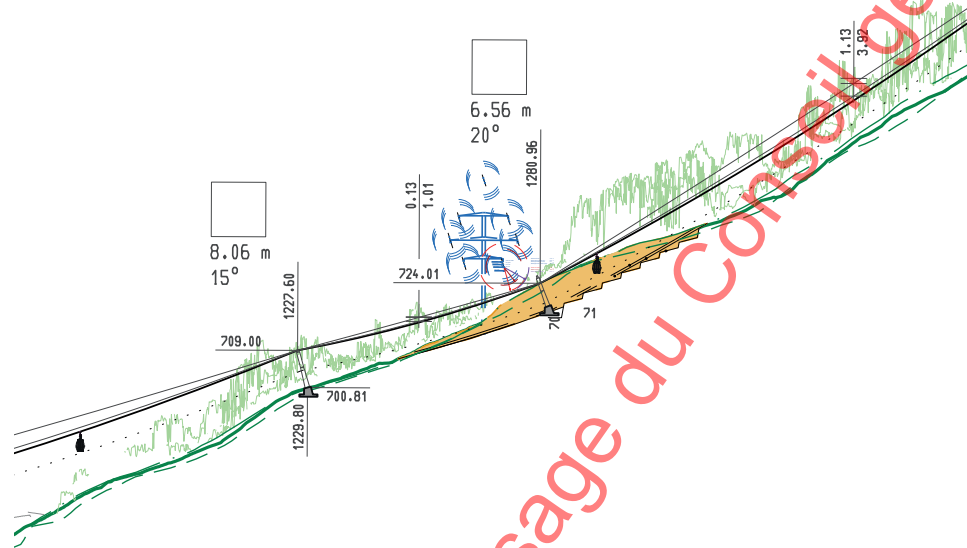

Tracé de la liaison

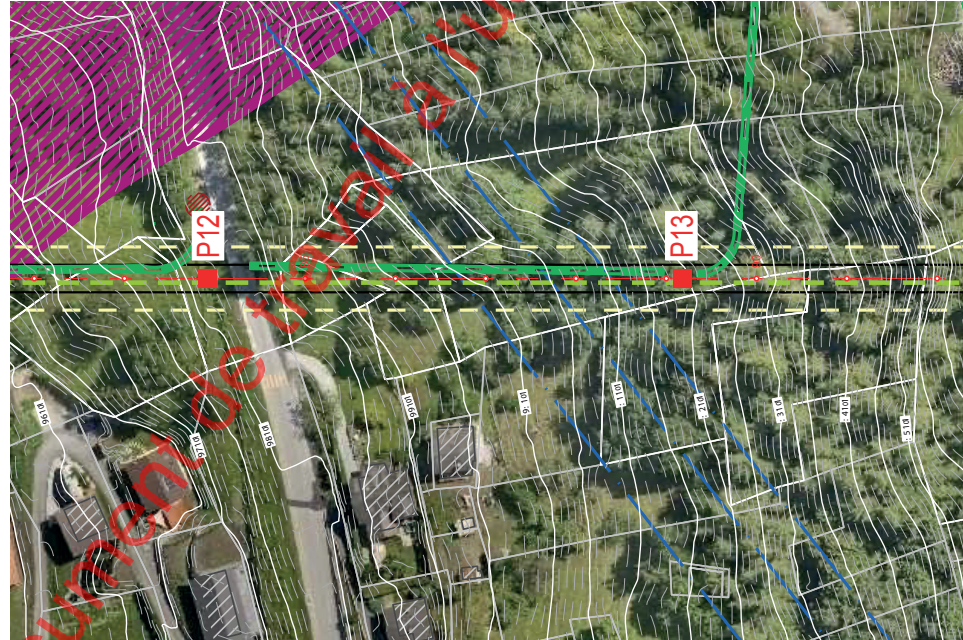
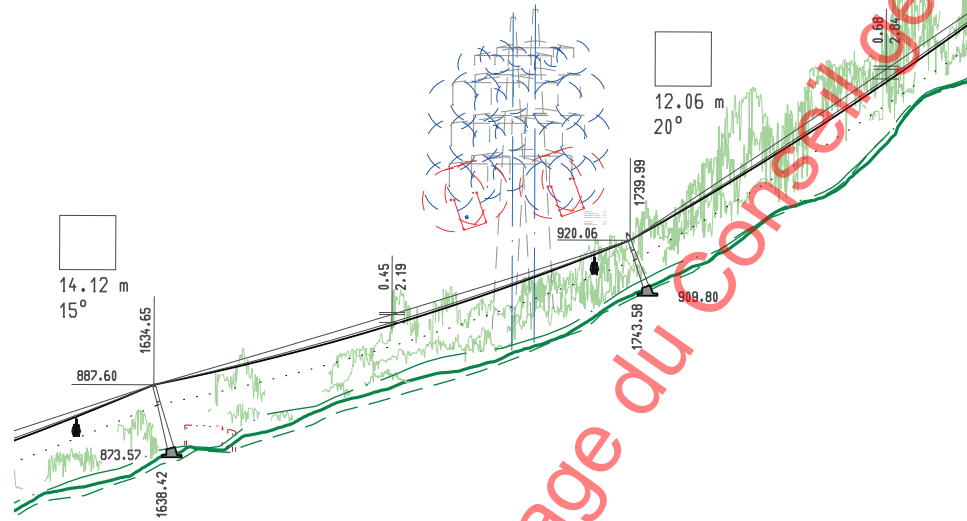

Tracé de la liaison

Document soumis au usage du Conseil Général

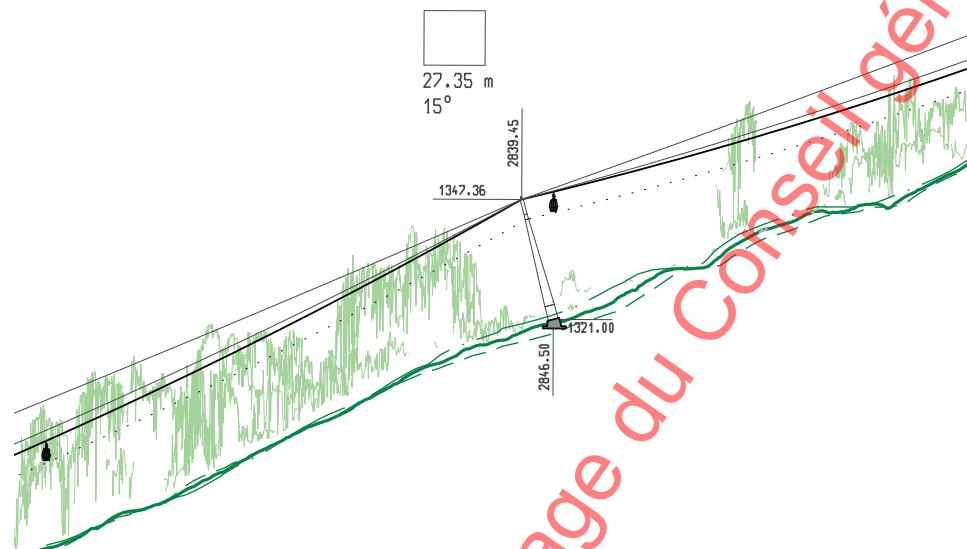

Tracé de la liaison

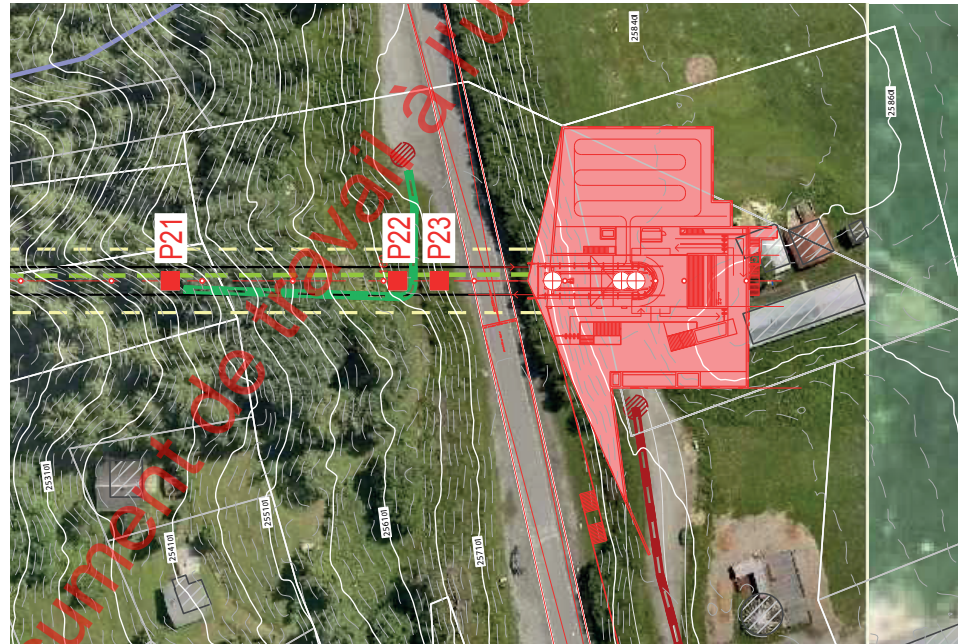
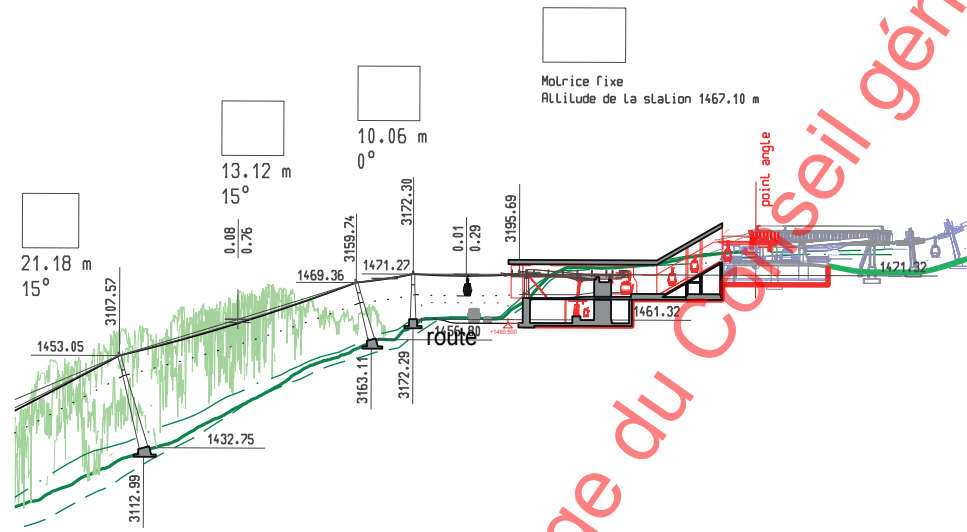

Tracé de la liaison

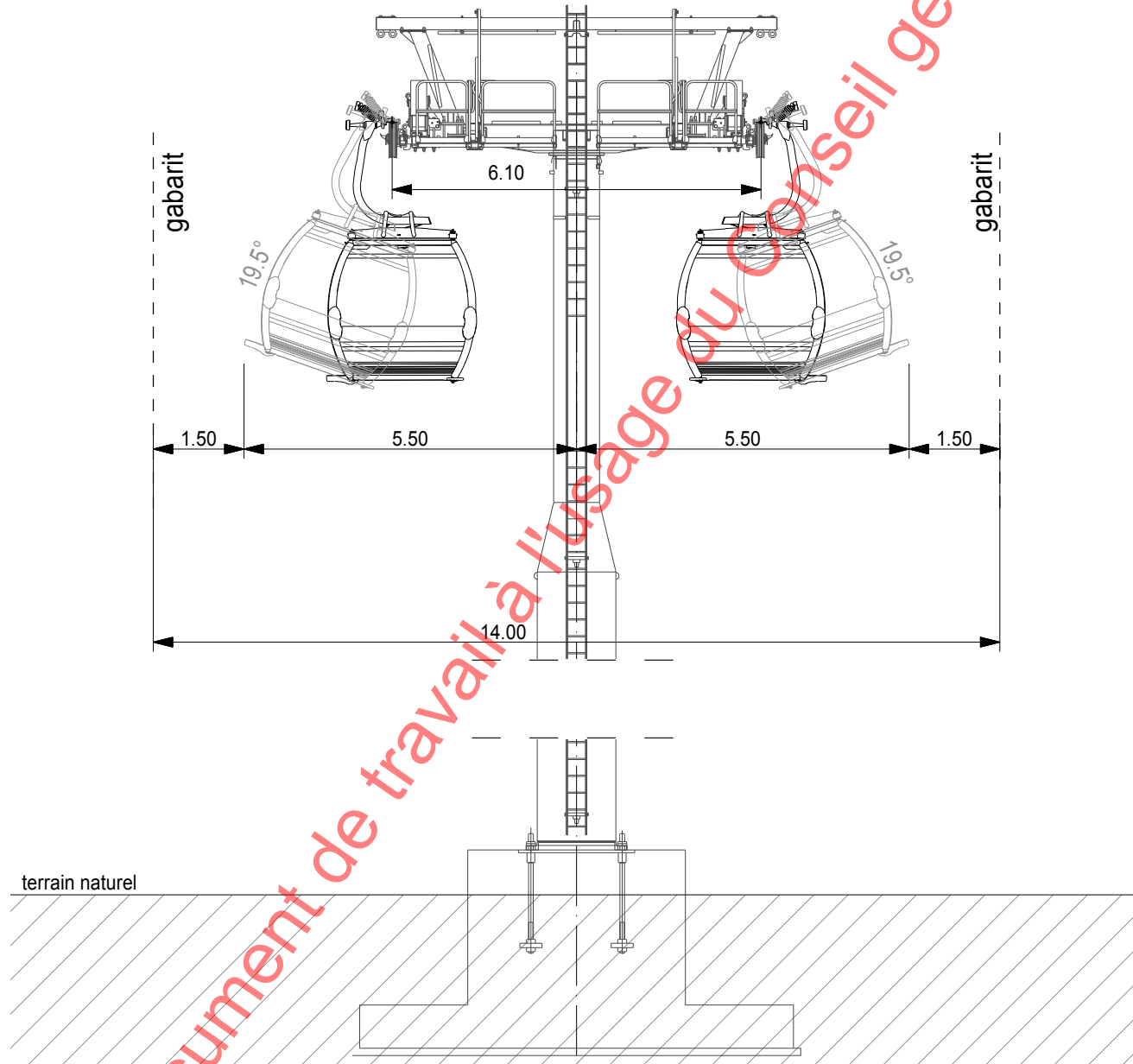

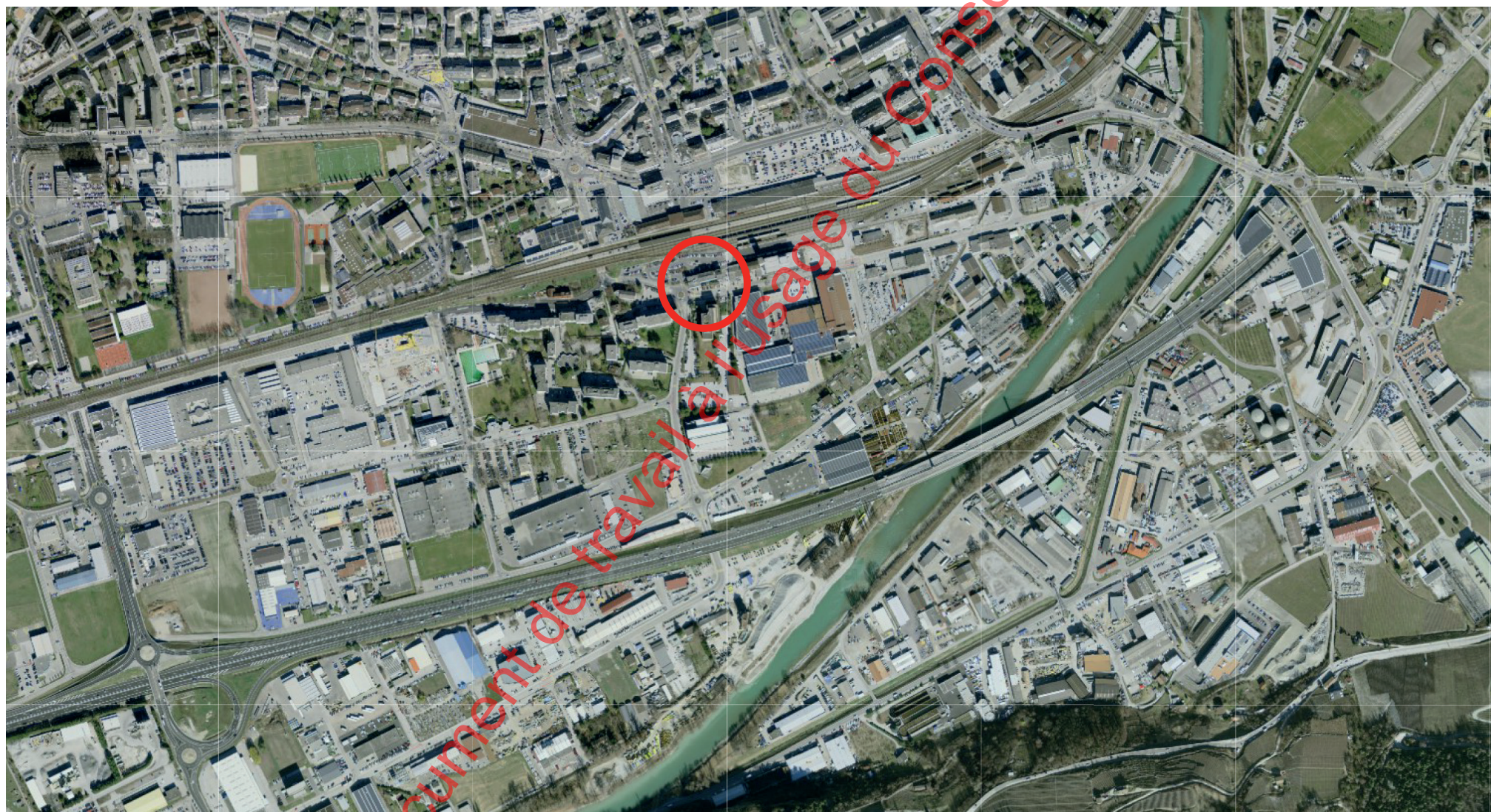

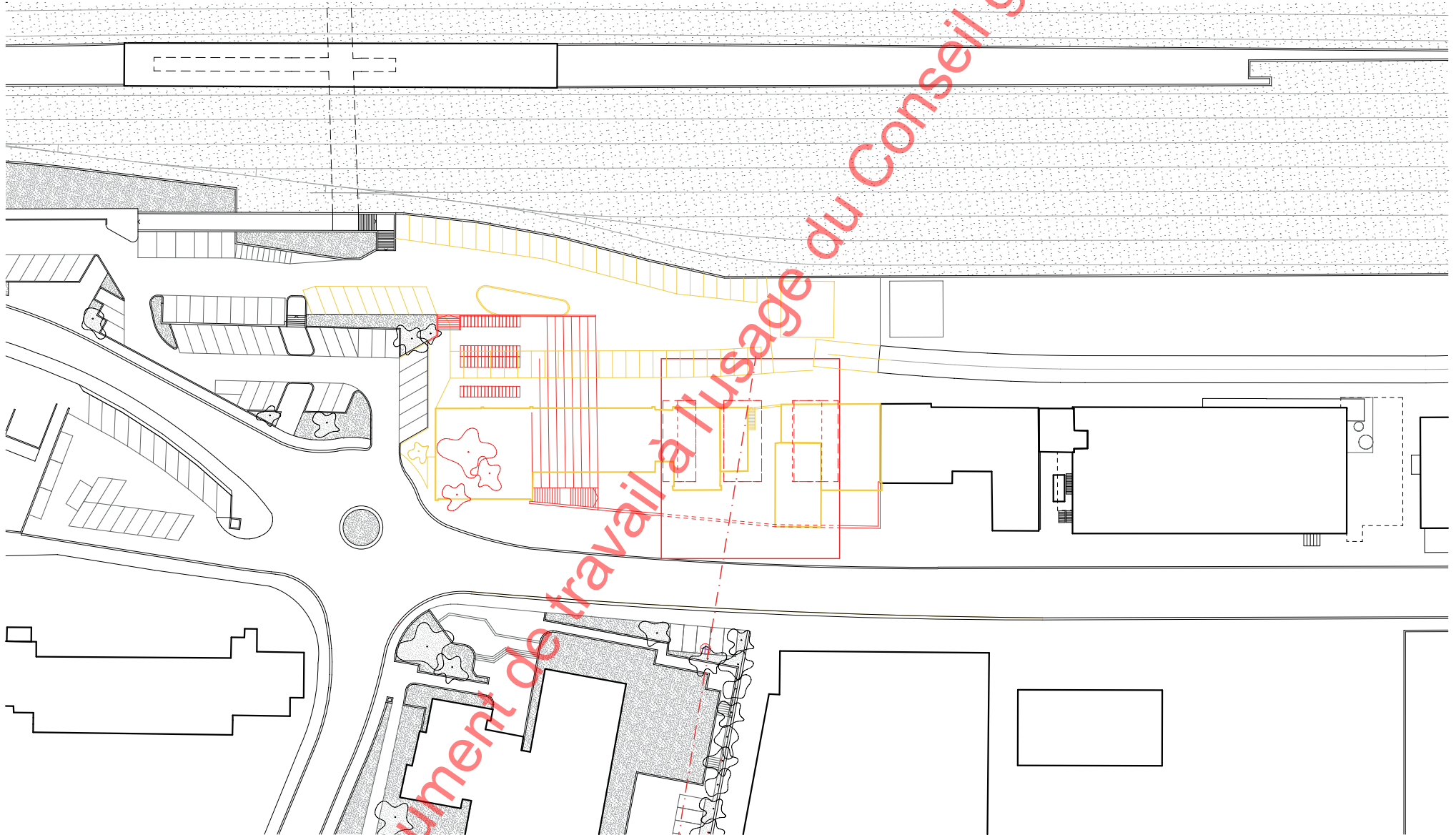

Implantation au sud de la gare

Document de travail à l'usage du Conseil général

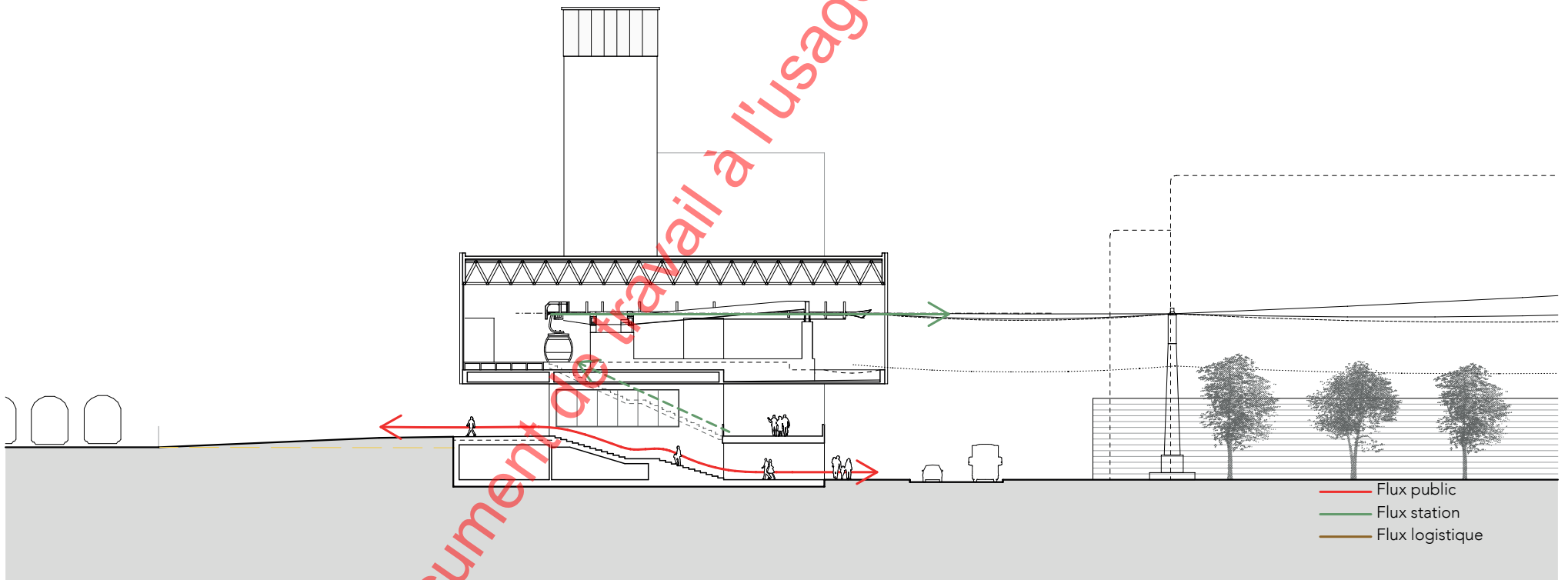

Coupe longitudinale

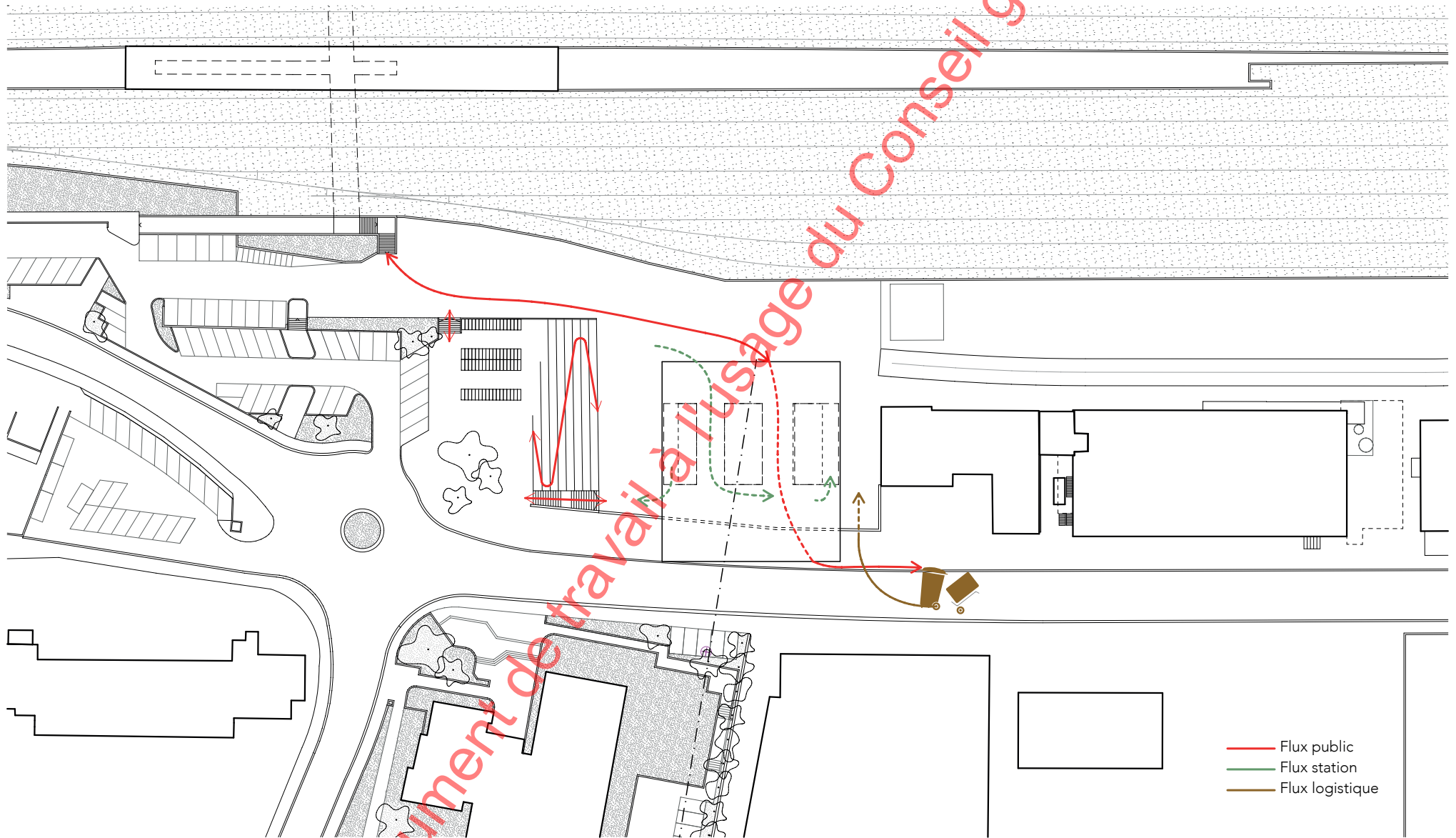

Fonctionnement station aval

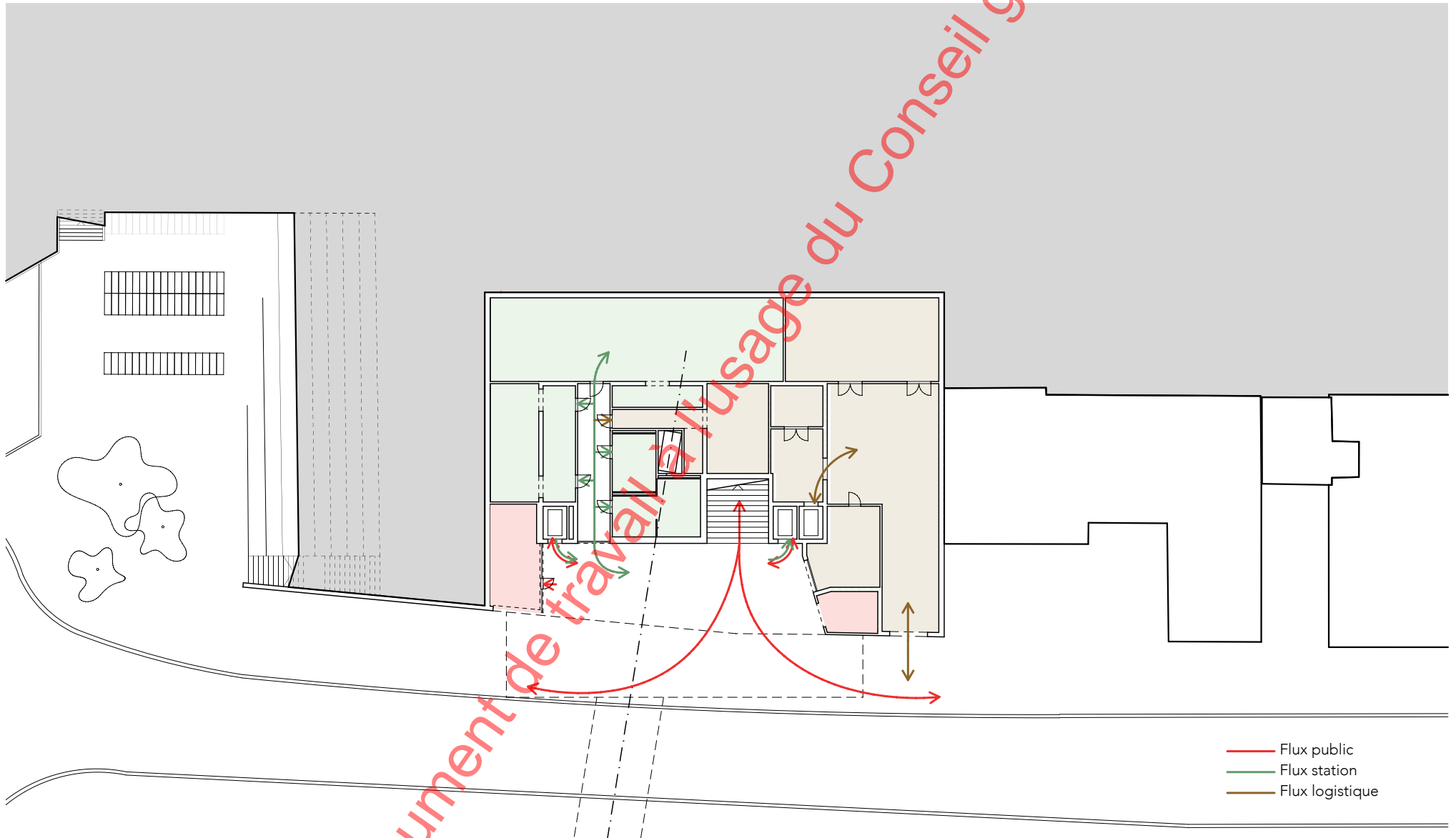

Plan niveau rue de l'Industrie

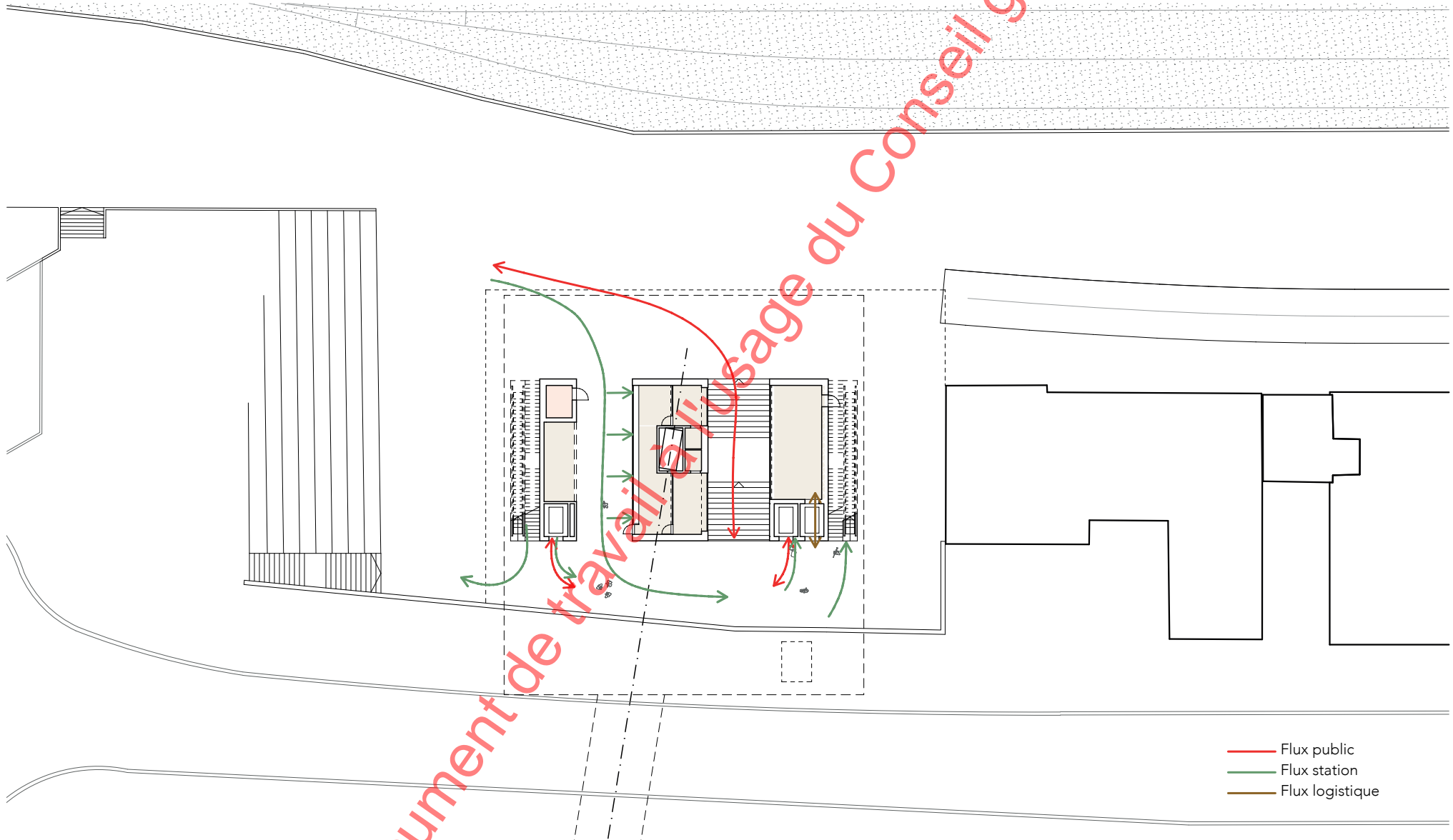

Plan niveau rue des Entrepôts

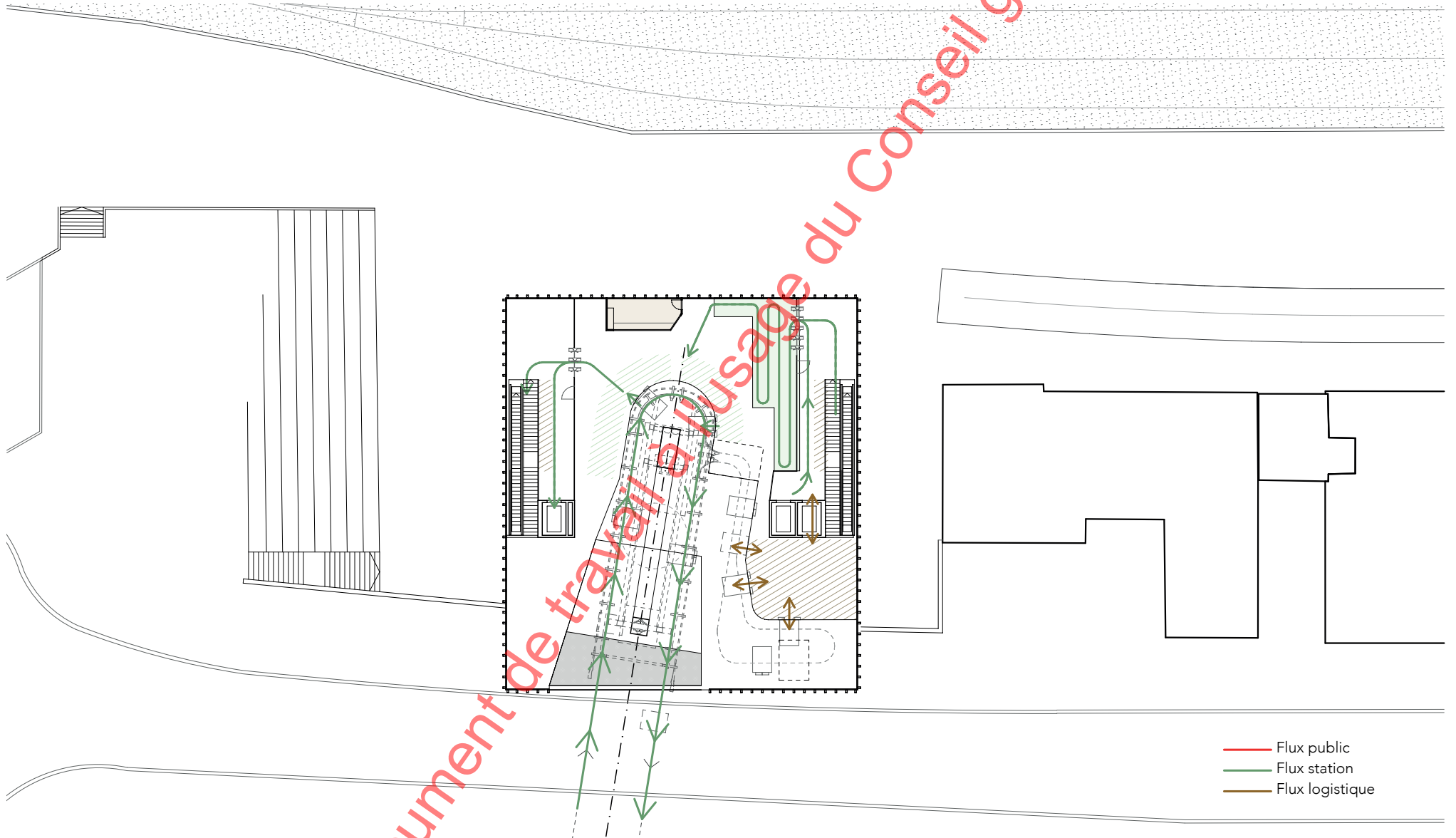

Plan niveau station

Document de travail à l'usage du Conseil général

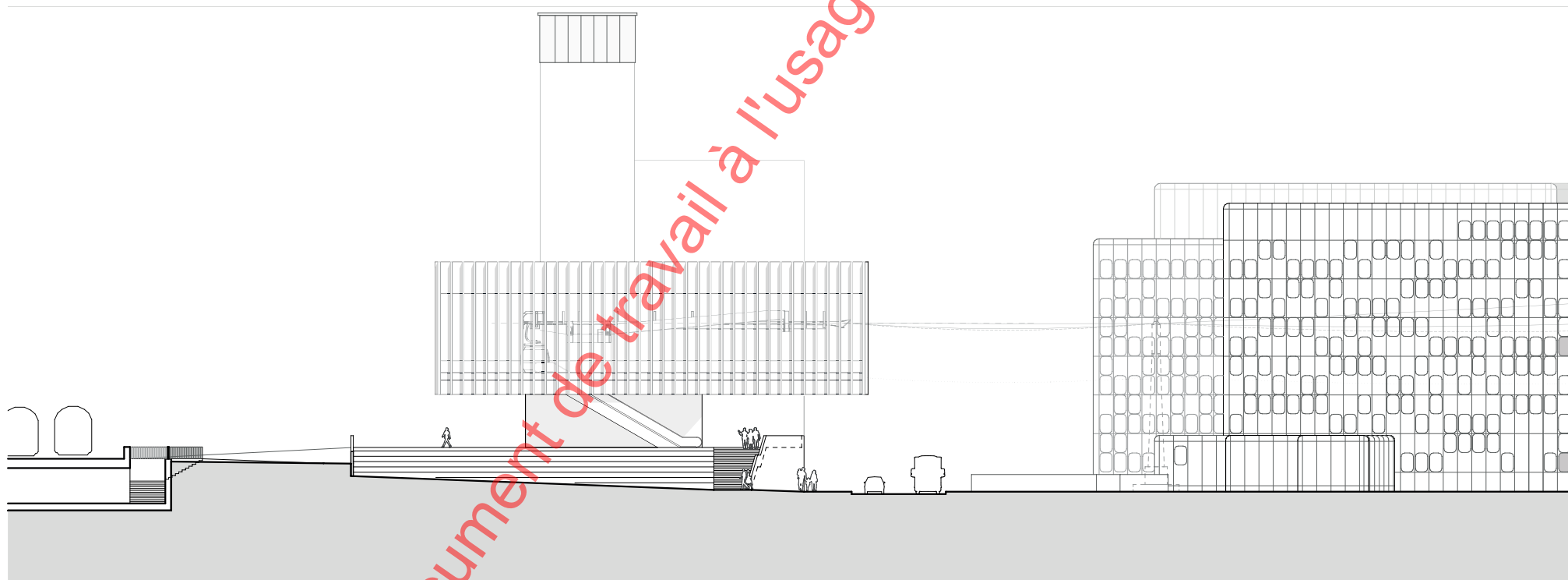

Façade Ouest

Document de travail à l'usage du Conseil général

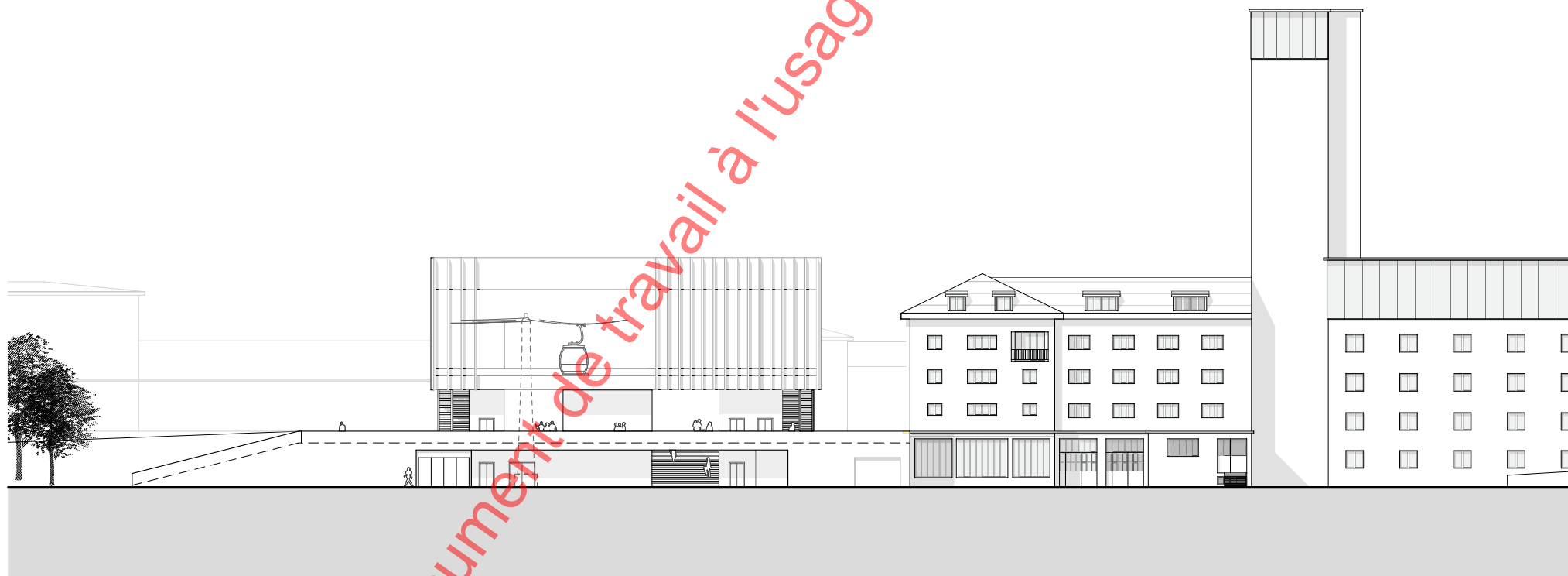

Façade Sud





Document de travail à l'usage du Conseil général



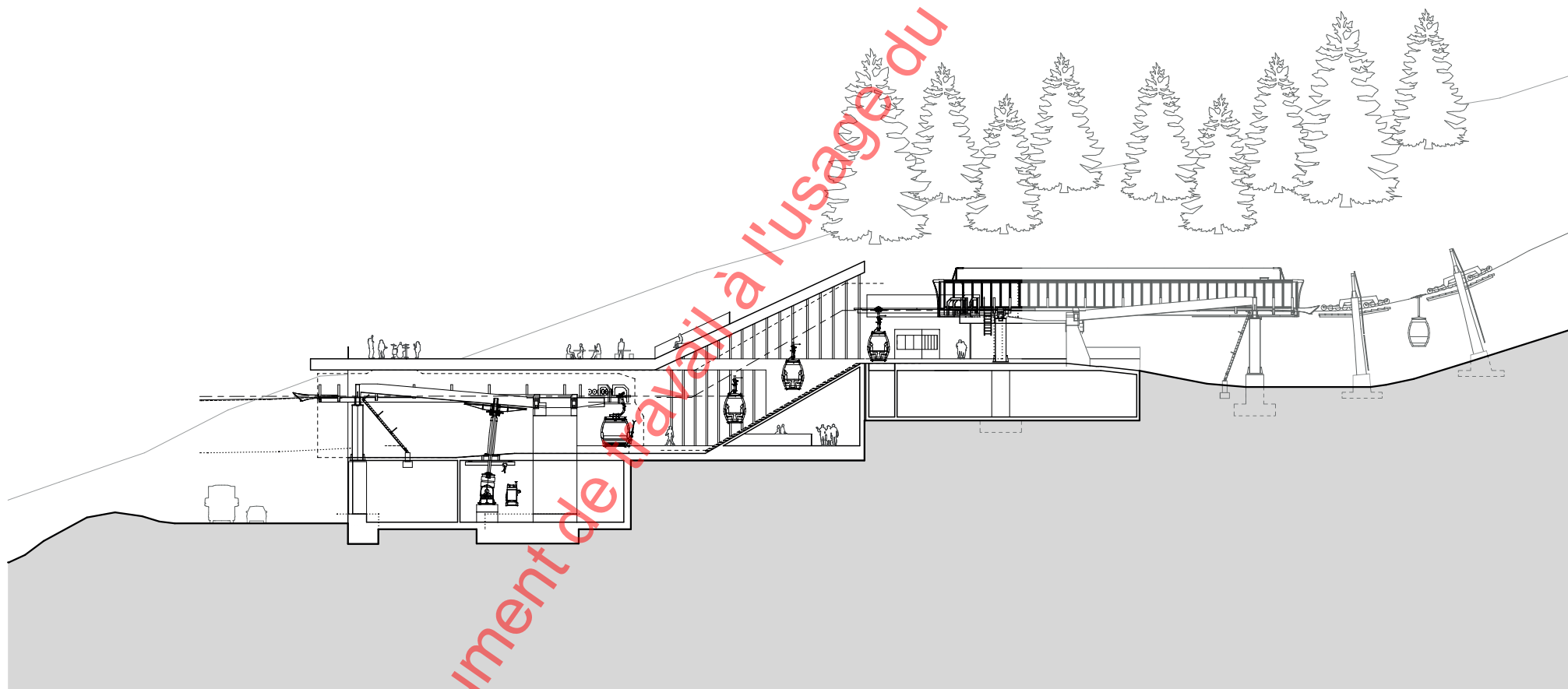

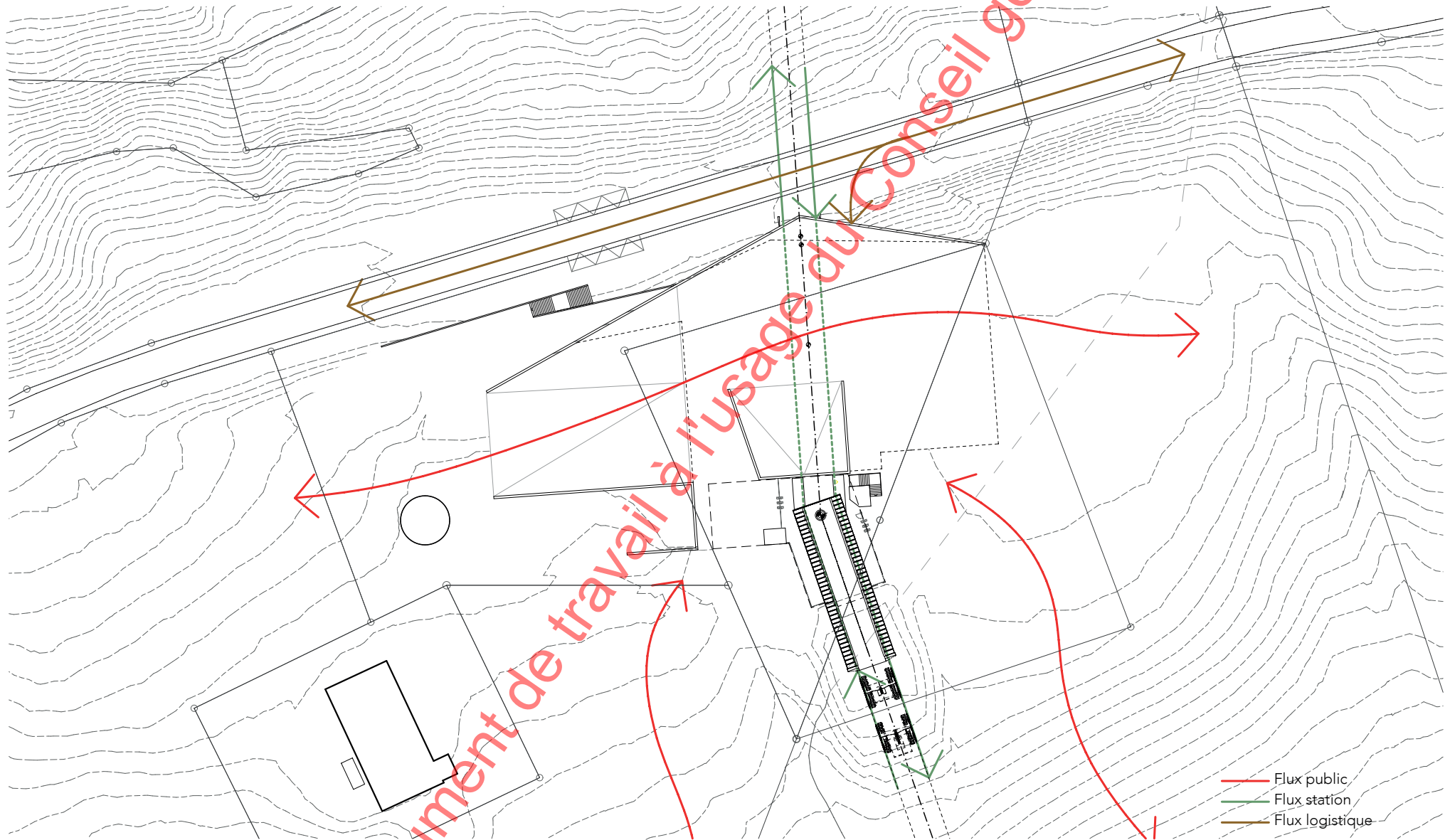

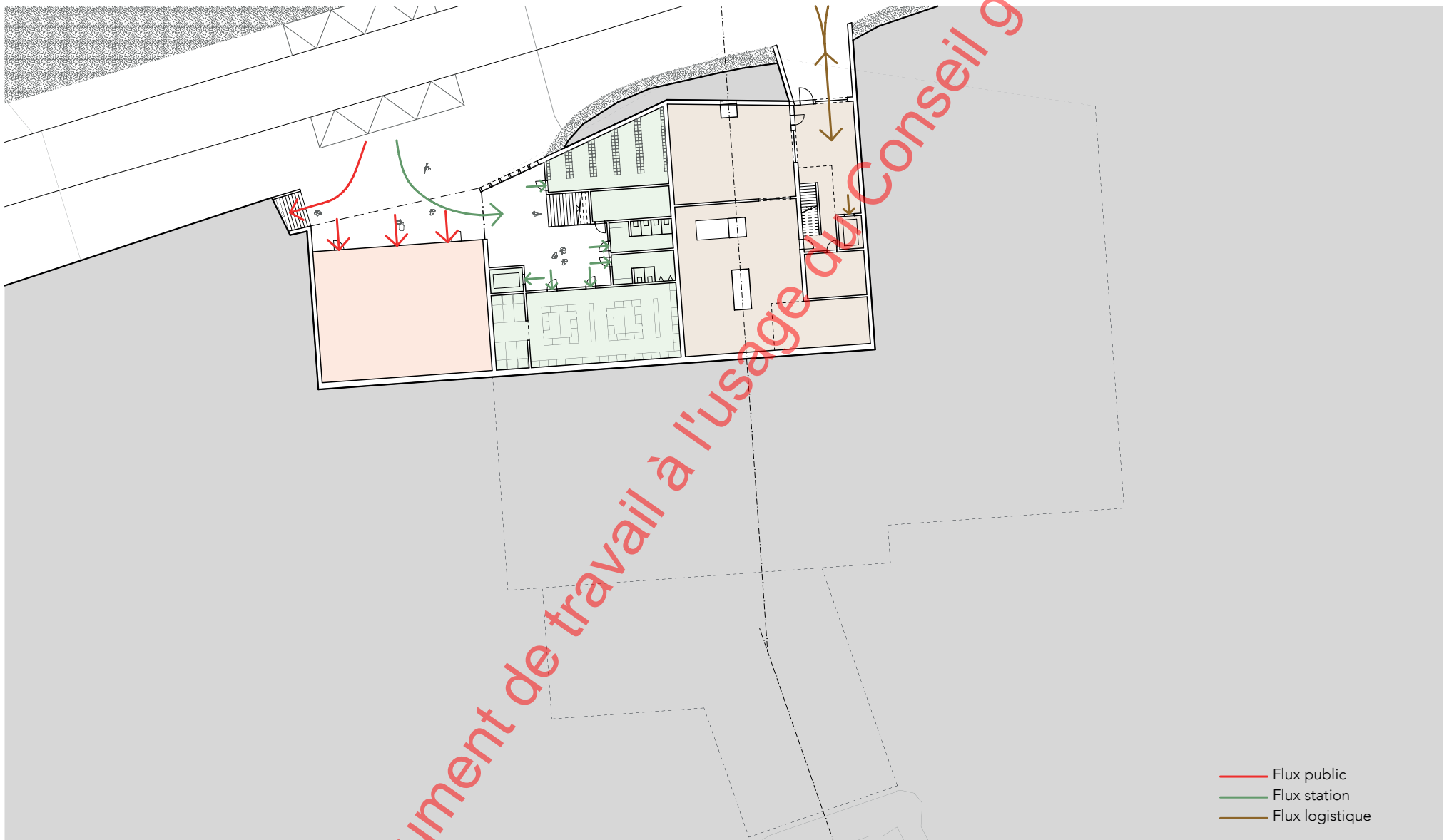

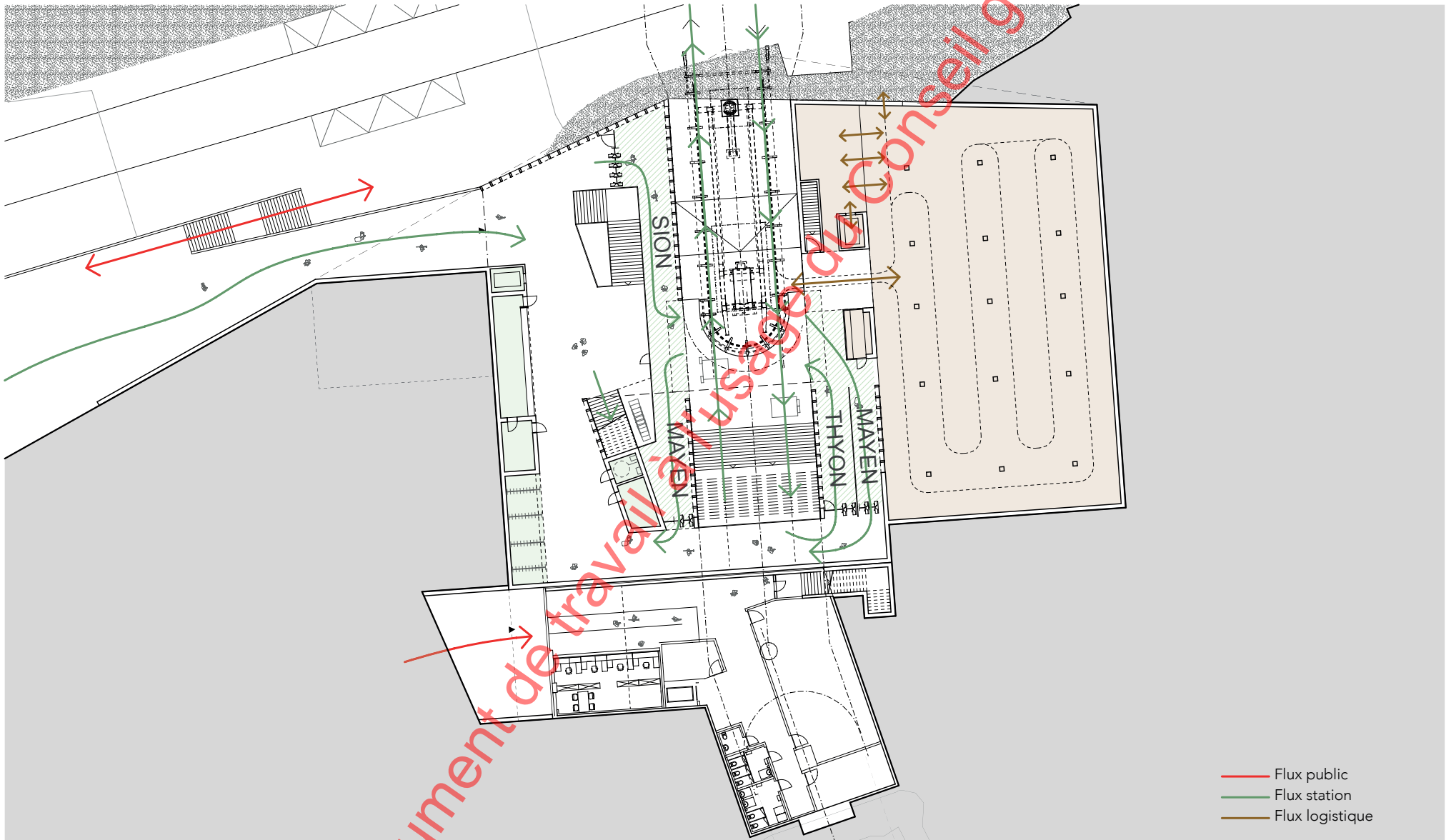

Plan niveau arrivée liaison plaine-montagne



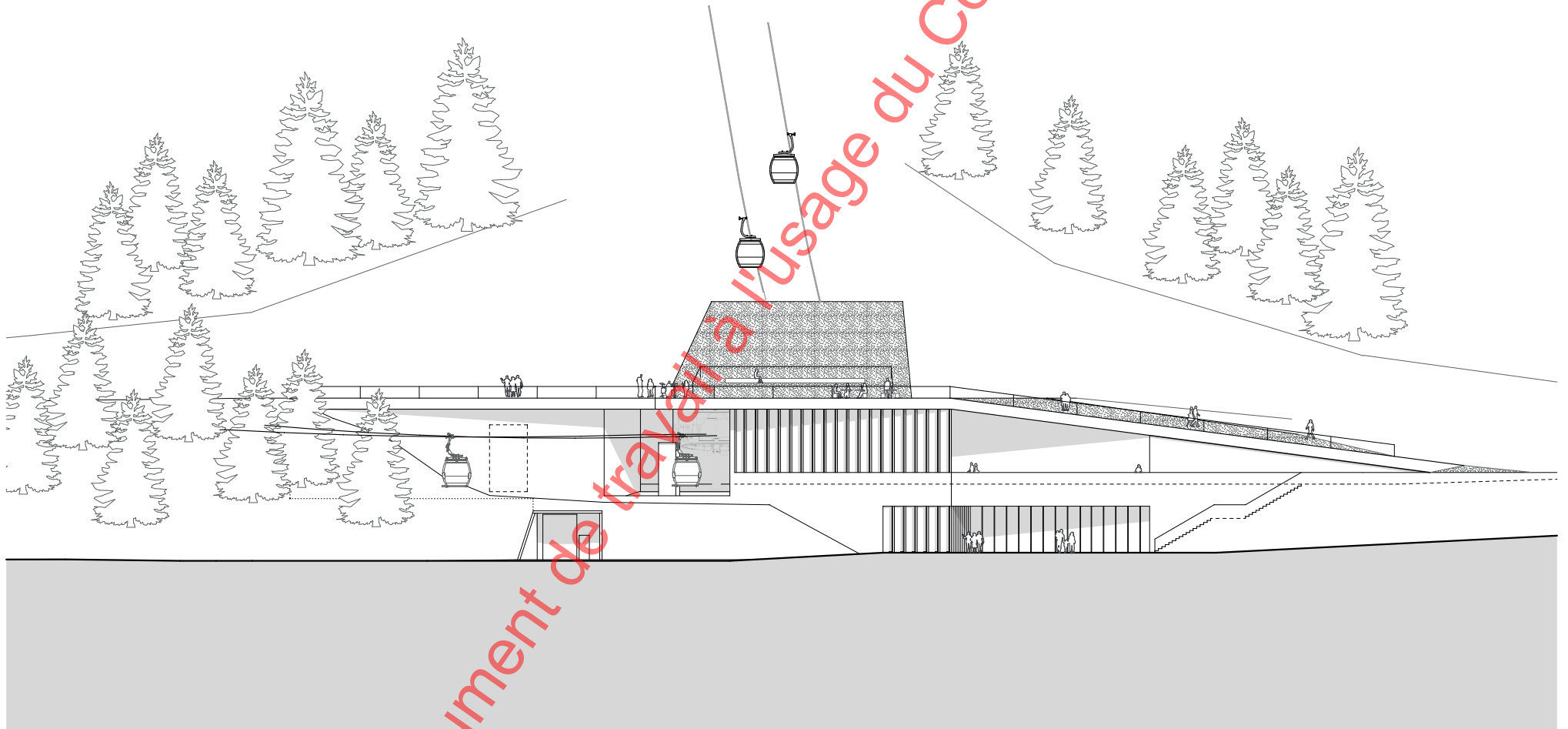

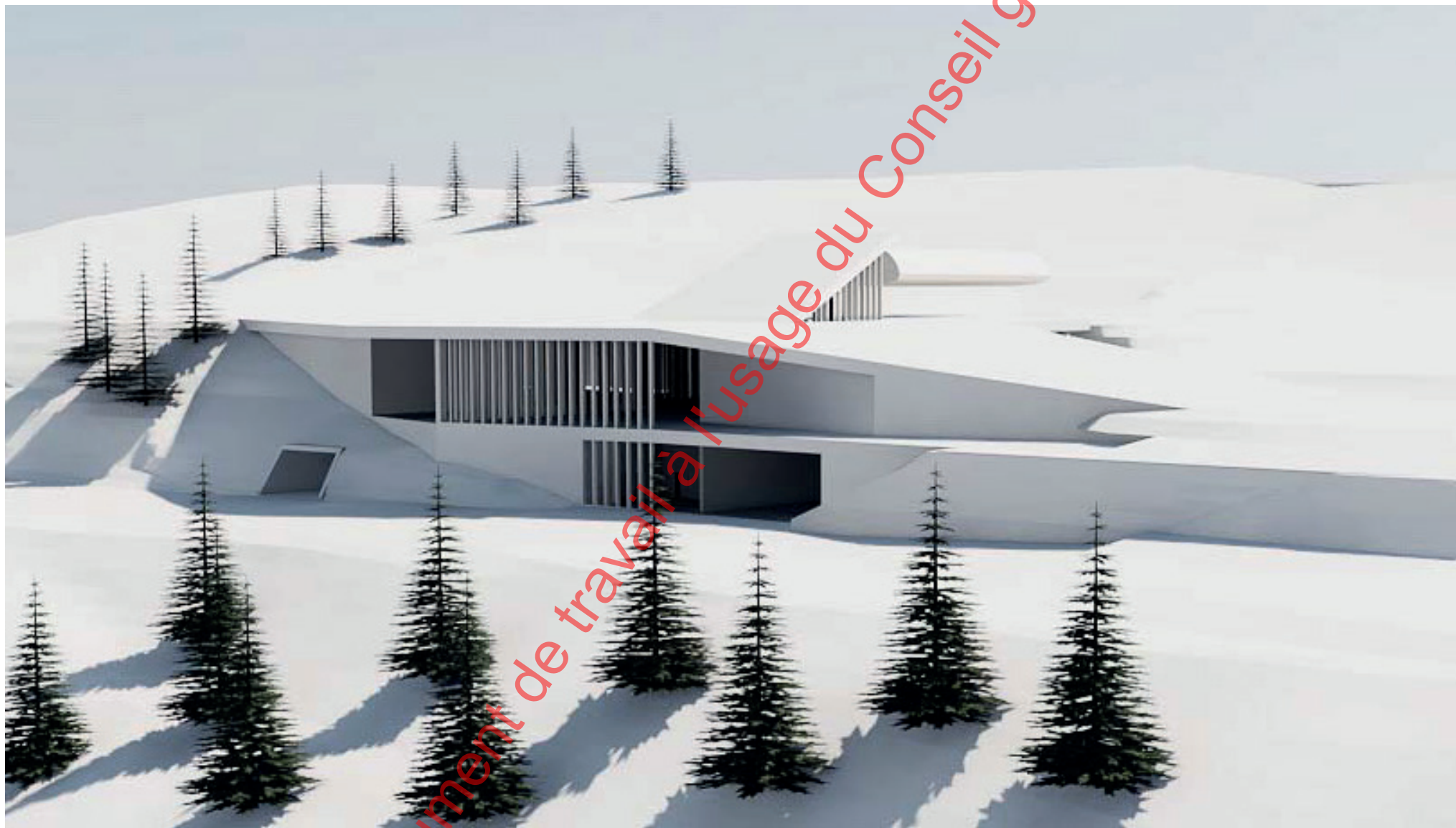

Merci pour votre attention